

# JEFFERSON CONCRETE CORP.

22850 MURROCK CIRCLE  
WATERTOWN, NY 13601  
TEL (315)788-4171 FAX (315)788-7958  
www.jeffersonconcrete.com

## 2,000 GALLON HEAVY DUTY OIL / WATER SEPARATOR

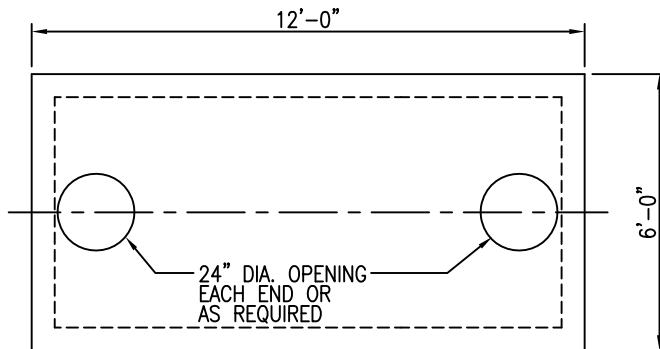

HEAVIEST PICK WEIGHT: 22,460 POUNDS

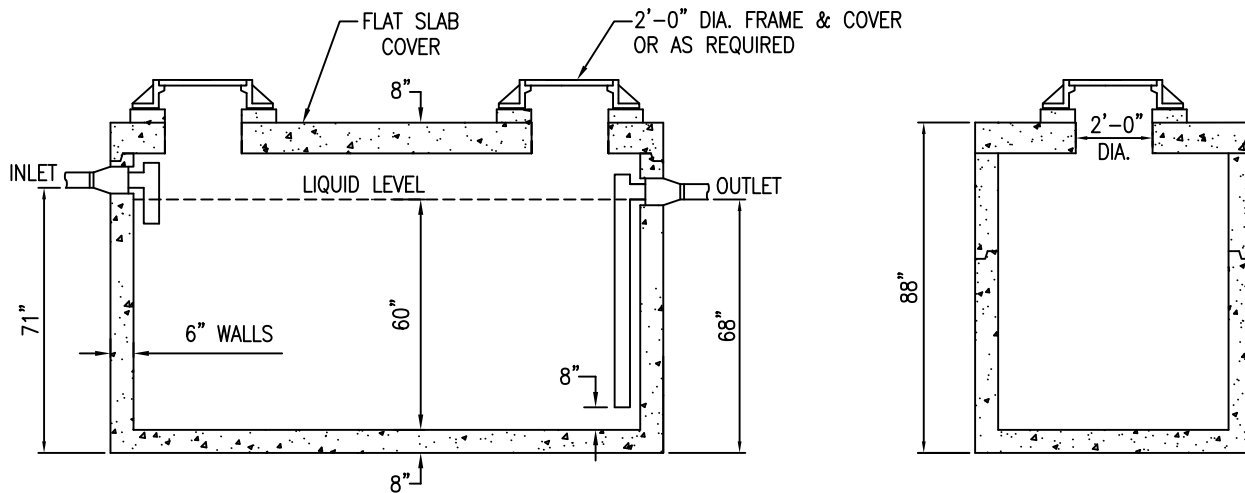

### GENERAL NOTES:

1. CONCRETE TO BE MIN. 5000 PSI @ 28 DAYS
2. ENTRAINED AIR 5%-8%
3. STEEL ASTM A497/A615 GRADE 60
4. BUILT IN ACCORDANCE TO ASTM C-1227/C-913 (HS-20 LOADING)
5. JOINTS SEALED IN ACCORDANCE TO ASTM C-990
6. PIPING BY OTHERS

UPDATED 05/08/10