

JEFFERSON CONCRETE CORP.

22850 MURROCK CIRCLE
WATERTOWN, NY 13601
TEL (315)788-4171 FAX (315)788-7958
www.jeffersonconcrete.com

4,000 GALLON HEAVY DUTY SEPTIC TANK

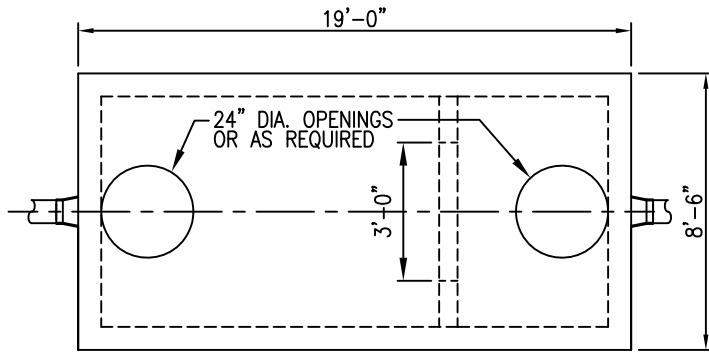

HEAVIEST PICK WEIGHT: 24,270 POUNDS

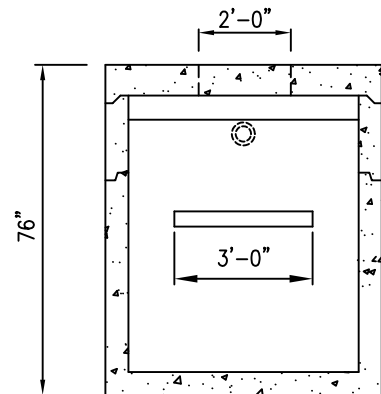
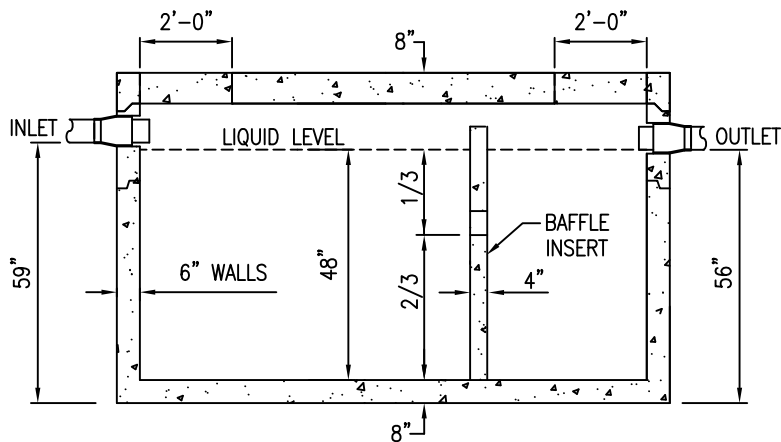

GENERAL NOTES:

CONCRETE TO BE MIN. 5000 PSI @ 28 DAYS
ENTRAINED AIR 5%-8%
STEEL ASTM A497/A615 GRADE 60
BUILT IN ACCORDANCE TO ASTM C-1227/C-913 (HS-20 LOADING)
JOINTS SEALED IN ACCORDANCE TO ASTM C-990

UPDATED 04/08/10