

# JEFFERSON CONCRETE CORP.

22850 MURROCK CIRCLE  
WATERTOWN, NY 13601  
TEL (315)788-4171 FAX (315)788-7958  
www.jeffersonconcrete.com

## 2,000 GALLON HEAVY DUTY SEPTIC TANK

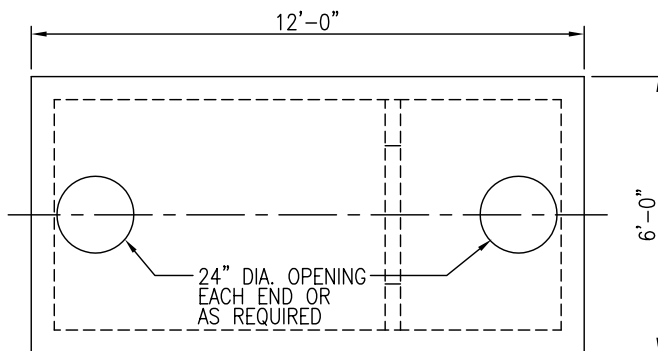

HEAVIEST PICK WEIGHT: 22,460 POUNDS

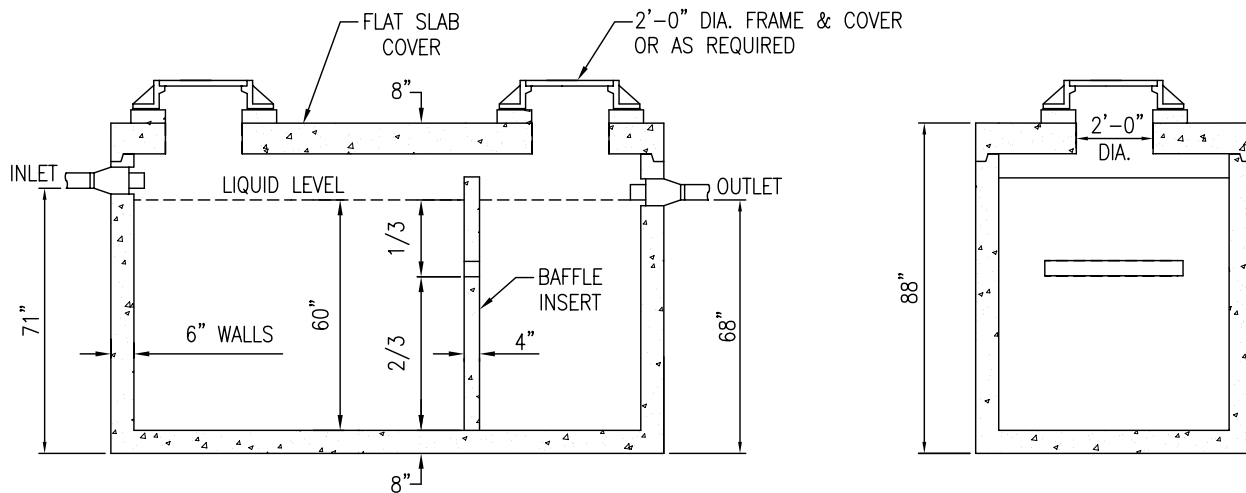

### GENERAL NOTES:

CONCRETE TO BE MIN. 5000 PSI @ 28 DAYS  
ENTRAINED AIR 5%-8%  
STEEL ASTM A497/A615 GRADE 60  
BUILT IN ACCORDANCE TO ASTM C-1227/C-913 (HS-20 LOADING)  
JOINTS SEALED IN ACCORDANCE TO ASTM C-990

UPDATED 10/05/12